

Mounting instructions

corrugated eternit / sandwich

- top-fix roof parallel

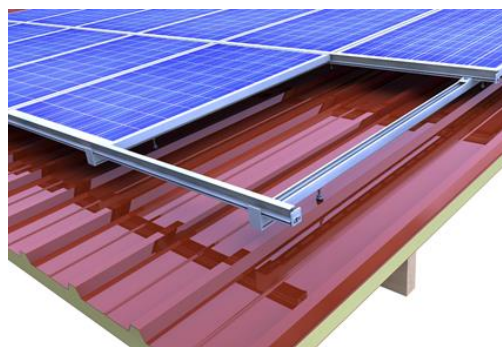
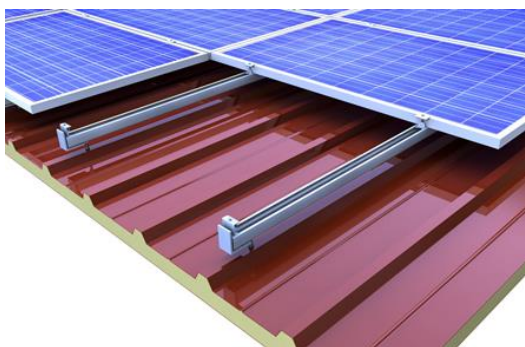
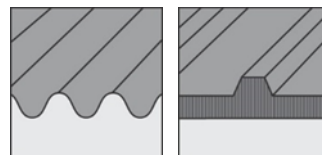

TABLE OF CONTENTS

1	Notes	1
2	Maintenance of the mounting system	4
3	novotegra corrugated eternit/sandwich roofs	4
4	System components, tools and equipment	5
4.1	What is required for mounting	5
4.2	Mounting system components – mounting versions	6
4.3	Mounting system components – optional.....	7
5	Installing the mounting system	8
5.1	Stock screw mounting	8
5.2	Rail mounting	9
5.3	Module mounting	10
5.4	Mounting versions.....	11
6	Warranty / product liability (exclusion)	17

1 Notes

The following instructions are generally valid for our mounting system novotegra and are to be applied or interpreted accordingly regardless of the respective roof and mounting system type.

Safety information

Mounting tasks may only be carried out by qualified and competent persons. During the work protective clothing in accordance with the relevant national regulations and guidelines must be worn.

Mounting must be carried out by at least two persons to ensure help in case of an accident.

All relevant national and locally applicable health and safety regulations, accident prevention regulations, standards, construction standards and environmental protection regulations as well as all regulations of the employers' liability insurance associations must be complied with.

The national regulations for working at height / on the roof must be complied with.

Electrical work must be carried out in compliance with the national and locally applicable standards and guidelines and the safety rules for electrical work.

Earthing / equipotential bonding of the mounting system must be carried out in accordance with the national and locally applicable standards and guidelines.

Categorisation into hazard classes

To alert the user of potential danger situations the hazard classes analogous to ANSI Z 535 are used. The hazard class describes the risk if the safety information is not observed.

Warning symbol with signal word

Hazard class analogous to ANSI Z 535



DANGER! describes an immediate danger. If it is not avoided, death or serious injury will result.



WARNING! describes a potential danger. If it is not avoided, death or serious injury might result.



CAUTION! describes a potential danger. If it is not avoided, light or minor injury might result.



NOTE! describes a potentially harmful situation. If it is not avoided, the plant or objects in its vicinity might be damaged.

General information

After receipt the goods must be inspected for completeness using the accompanying delivery note.

novotegra GmbH does not accept the costs, nor can we guarantee subsequent express deliveries if missing material is only noticed during mounting.

Since our mounting systems are subject to continuous development, mounting processes or components may change. Therefore, please check the current status of the mounting instructions on our website prior to mounting. We are also happy to send you current versions upon request.

The mounting system is suitable for the attachment of PV modules with standard market dimensions. Please find more detailed information about this in chapter 3.

The usability of the mounting system for the respective project must be checked for each individual case on the basis of the roof cover / roof construction / facade present.

The roof cover / roof construction / facade must meet the requirements of the mounting system with regard to load bearing capacity, support structure and condition.

Requirements for the material of the roof construction / roof cover / facade:

Wooden components (rafters/purlins): min. strength class C24, no fungus infection or rot

Tensile strength R_m , min for trapezoidal metal: steel 360 N/mm²; aluminium 195 N/mm²

Wall construction material: concrete, brick or sand-lime brick in solid or hollow block design.

The load bearing capacity of the roof / roof construction (rafters, purlins, trapezoidal metal, concrete floors, number of adhesive points, folded seams, etc.) or the facade (wall construction materials) must be checked by the user or a check be commissioned.

Physical building aspects concerning insulation penetrations (e.g. condensation) must be taken into account by the user.

Notes on mounting

The components of the novotegra mounting system are intended exclusively for the attachment of PV modules. Dependent on the roof type of the building the designated mounting system components must be used.

A condition for the intended use of the novotegra mounting system is the mandatory compliance with the specifications in these instructions regarding safety information and mounting.

In case of unintended use and non-compliance with the safety information and mounting instructions and non-utilisation of the corresponding mounting components or use of third party components not belonging to the mounting system any warranty and liability claims against the manufacturer are voided. The user is liable for damage and resulting consequential damage to other components, such as PV modules, or the building as well as personal injury.

The user must read the mounting instructions prior to mounting. Unresolved issues must be clarified with the manufacturer prior to mounting. The mounting sequence in these instructions must be adhered to.

It must be ensured that a copy of the mounting instructions is accessible in the immediate vicinity of the work on site.

The mounting specifications (module load, attachment, clamping areas etc.) of the module manufacturer must be observed and complied with.

Prior to mounting the mounting system must be statically calculated with the loads to be assumed for the building project in accordance with the national standards. Information relevant to mounting (e.g. roof hook distance, lengths of bolts, overhang and protrusions or distance of base trough and required ballast) must be determined by the static calculation using the design software www.solar-planit.

The permissible roof inclination for using the mounting system according to these installation instructions is 0 to 60 degrees for roof-parallel installation on a pitched roof and 0 to 5 degrees for elevated installation on a flat roof. Facade systems must be mounted parallel to the facade.

For roof-parallel installation with the clamping system, two module support rails per module must be mounted symmetrically under the modules for equal load transfer into the substructure. Alternatively, the roof-parallel installation can also be installed with insertion rails.

The specified tightening torques must be adhered to and checked randomly on site.

Notes on static calculations

The mounting system must generally be statically calculated for each individual project using the design software Solar-Planit. Excluding façade systems, the calculation for this will be carried out by the company novotegra GmbH.

The static calculation only determines the load bearing capacity of the novotegra mounting system and also takes account of the attachment to the building (rafters, purlins, trapezoidal metal, facade etc.). The load transfer within the building is not considered (customer static calculations).

The load bearing capacity of the mounting system components is determined on basis of the planned module layout and the underlying building information (project data recording). Deviations from the planning on site may lead to different results.

The load assumptions (load and roof division) are country-specific in accordance with the specifications of the Eurocode load standards. The determination of the loads to be assumed for Switzerland is in accordance with SIA 261.

At pitched roof, the modules may not be fitted above the gable end, ridge and eaves or the facade (increased wind load). At the ridge the modules may be fitted up to max. a theoretical horizontal line with the ridge tile and perfectly flush with the gable end. In the eaves area the modules may reach to max. the end of the roof cover due to loads.

In case of an exposed building position (with wind load e.g. at the edge of a slope) or snow accumulation (e.g. dormer or catchment grill or roof structures like domelights etc) the specifications of the Eurocode load standards or SIA 261 (Switzerland) must be taken into account by the user within his own responsibility. The design software does not consider these cases.

The static calculation of the mounting system is based on the symmetrical placement of the modules on the mounting rails at the longitudinal side of the modules (roof-parallel clamping systems) or on the support components (elevation) for equal load transfer into the substructure. For the insertion system a cross rail arrangement is expected for equal load transfer.

The results calculated with the design software, such as distances of the fasteners (e.g. roof hooks, stock screws, saddle clamps etc.), rail lengths and number of fasteners (e.g. direct attachment on the trapezoidal metal), overhang (e.g. rail and roof hook protrusions) or distances between the base troughs and number of fixing materials (e.g. rail joint) and the other calculation notes must be considered and complied with.

novotegra has been tested and certified by TÜV Rheinland:



2 Maintenance of the mounting system

The mounting system must be checked for stability and operation at regular intervals during the system maintenance.

In addition to the visual inspection of the components, we recommend a random check of the connections and the safe and correct position of the ballast on the base rails and ballast troughs.

Removal is possible in reverse order in the work steps mentioned below.

The maintenance work must be carried out by a specialist company with proven experience in electrical systems and work on mounting systems.











3 novotegra corrugated eternit/sandwich roofs

The content of these mounting instructions describes the design of the mounting system on roofs with corrugated eternit, corrugated and trapezoidal metal and sandwich profiles. The maximum permissible module width is 1.34 m for the respective mounting system to be used.





In connection with metal shingles stock screws can also be used e.g. on shingle roofs. For the mounting of photovoltaic systems on roof covers containing asbestos the corresponding guidelines and health and safety regulations must be complied with.

4 System components, tools and equipment

4.1 What is required for mounting

Figure	Tool	Component*	Product group
		Stock screw set Material: stainless steel Tool: Socket AF 7 or 9	Roof attachment
		C-rail Material: Aluminium	Profile rails
		Rail connector set C Material: Aluminium and stainless steel Tool: Special socket AF 18 deep	Rail connectors and expansion joint
Clamping system			
		Middle clamp sets C Material: Aluminium, aluminium cast and stainless steel Tool: Socket AF 8	Module attachment
		End clamps sets C Material: Aluminium, aluminium cast and stainless steel Tool: Socket AF 8	Module attachment
		Module slip guard set Material: stainless steel	Module protection and rail top cover







* The components vary dependent on the roof requirements, the static calculation or the component selection and may differ from the figures above.

Figure	Equipment	Use for tools	Application
	Battery-operated screwdriver	Torx TX bit 40 or 25 Socket AF 8	Component attachments, clamp mounting
	Torque spanner up to min. 50 Nm	Special socket AF 18 deep or socket AF 13	Rail assembly
	Torque spanner up to min. 10 Nm	Socket AF 8	Clamp assembly
	Mitre saw	---	Rail section
	Spiral drill bit	Drill bit diameter (mm): 6.8; 7.0; 7.2; 7.4; 7.5; 9.0; 14.0; 16.0	Drill or predrill roof construction

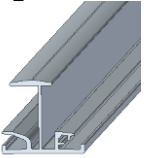
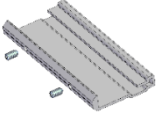
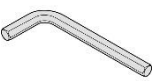
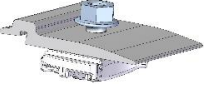
4.2 Mounting system components – mounting versions

Figure	Tool	Component**	Product group
		Metal shingle Material: Aluminium	Accessories and optional components
		Cross rail connector set C M14 Material: Aluminium cast and stainless steel Tool: Special socket AF 18 deep	Rail connectors and expansion joint
		Expansion joint Material: Aluminium and stainless steel Tool: Special socket AF 18 deep	Rail connectors and expansion joint
		Slip guard for landscape mounting Material: Aluminium and stainless steel Tool: Special socket AF 18 deep	Module protection and rail top cover

Insertion system

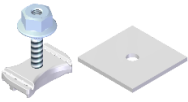

Figure	Tool	Component**	Product group
		Insertion rail Material: Aluminium	Profile rails
		Rail Connector set IR Material: Aluminium and stainless steel Tool: Hexagon socket AF 3	Rail connectors and expansion joint
		Cross rail connector set C IR M8 Material: Aluminium and stainless steel Tool: Socket AF 13	Rail connectors and expansion joint
		Support rail IR Material: Aluminium	Profile rails
		Insertion rail Plus Material: Aluminium	Profile rails
		Edge stop set IR Material: Aluminium and stainless steel Tool: Torx TX bit 30	Module protection and rail top cover
		EPDM-T protection IR Material: EPDM	Module protection and rail top cover

** Required components dependent on the substructure (e.g. cross rail arrangement), system design (e.g. with expansion joint) or module layout (e.g. mounting modules in landscape).

Figure	Tool	Component**	Product group
		Mounting set snowguard IR Material: Aluminium and stainless steel Tool: Socket AF 8	Accessories and optional components
		Snowguard IR 20 x 5 Alu round pipe Material: Aluminium	Profile rails
		Edge stop set IR Plus Material: Aluminium and stainless steel Tool: Torx TX bit 30	Module protection and rail top cover

** Required components dependent on the substructure (e.g. cross rail arrangement), system design (e.g. with expansion joint) or module layout (e.g. mounting modules in landscape).

4.3 Mounting system components – optional

Figure	Tool	Component***	Product group
		End cap for C-rail Material: Aluminium and stainless steel Tool: Special socket AF 18 deep	Module protection and rail top cover
		Top cover C-rail 2,000 mm Material: Aluminium	Module protection and rail top cover
		End cap C-rail black	Module protection and rail top cover
		Mounting-Set C-rail with plate	Accessories and optional components
		Grounding connector set AF 18 Material: stainless steel Tool: Special socket AF 18 deep	Accessories and optional components
		Cable-tie clip for profile flange	Cable fixing
		Cable clip d = 10 mm	Cable fixing
		Contact latch module clamp	Accessories and optional components

*** Optionally available mounting system components e.g. for the visual enhancement of the system, cable laying or the earthing of the mounting system.

5 Installing the mounting system

Prior to mounting, the module field on the roof must be measured and the position of the fasteners (e.g. roof hooks, stock screws, saddle clamps etc.) defined taking into account the static calculation.

The individual mounting steps are described below for mounting modules in landscape in the clamping system for corrugated cement fibre roofs. The mounting steps can be applied correspondingly to the installation on other roof types. Additional mounting versions (MV) for the various design options (e.g. insertion system or cross rail mounting) are described in the chapter "Mounting versions".

5.1 Stock screw mounting

Determining the position of the mounting rail

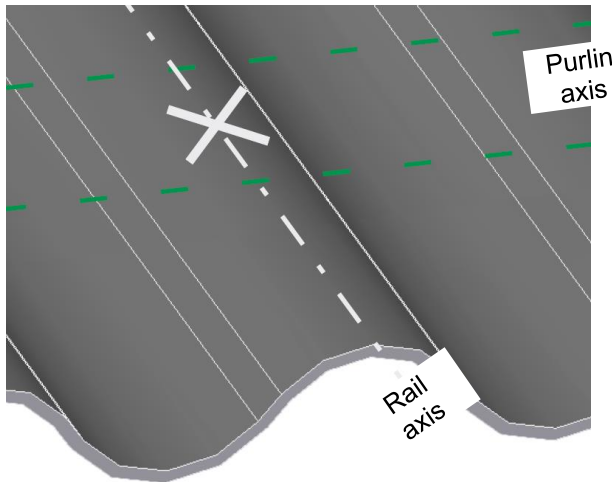

Draw the axis of the mounting rails on the corrugated crests / raised beads.

Mark the position of the stock screws along the rail axes above the purlins.

For steel purlin constructions note MV 1.

⚠ WARNING

To execute the work a scaffold must have been installed in accordance with the relevant specifications.

Observe accident prevention regulations, remove drill residue.

Mounting the stock screw

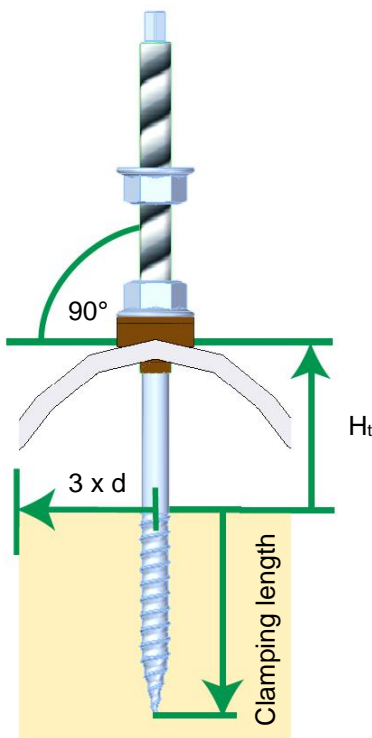

Predrill the wooden purlins through the roof cover then drill out the roof cover. Next screw the stock screws vertically into the purlin.

Stock screw set:	M10	M12
Distance to the purlin edge:	30 mm	36 mm
Predrilling of wooden purlin:	7.5 mm	9 mm
Drilling out of roof skin:	14 mm	16 mm
Clamping length:	>40 mm	>60 mm

NOTICE

Stock screw length dependent on the height of the roof cover.

Height of cover H_t *	Stock screw length
up to 60 mm	200 mm
61 – 110 mm	250 mm
111 – 160 mm	300 mm

*for clamping length 80 mm

Correct fit of EPDM seal

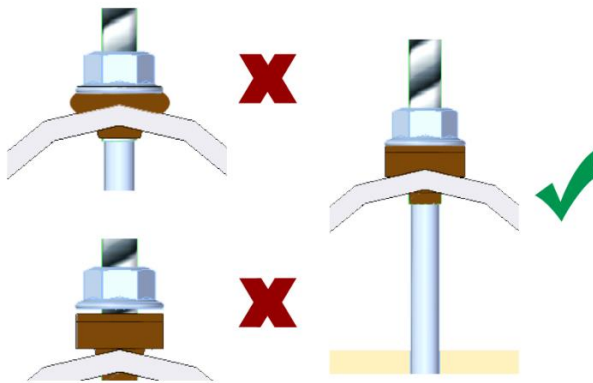

Tighten the lower self-locking nut until the EPDM seal is slightly compressed – the seal cone enters the predrilled hole of the roof cover.

WARNING

Sealing properties require the stock screws to be screwed in vertically.

5.2 Rail mounting

Mounting the rail

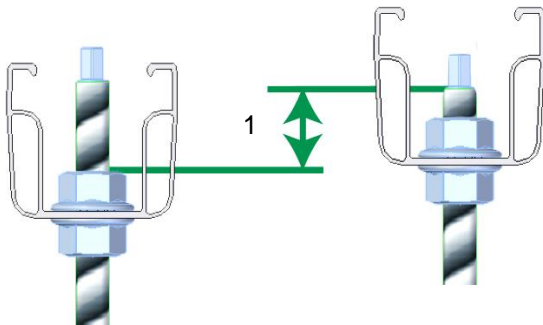

Place the C-rail onto the lower self-locking nut, adjust the rail height by appropriate positioning of the self-locking nut (1). Then tighten the upper self-locking nut.

The stock screw can also be connected to the rail connector in the joint area.

NOTICE

Self-locking nut tightening torque 50 Nm
The upper self-locking nut must sit fully within the thread area of the stock screw.

Connect the rail



Join the rail ends flush. Apply the rail connector centred and connect it to the rail using the fastening screws included in the set. The connector and number of screws depend on the rail (MV 3).

Maximum uninterrupted rail length 8.5 m, then install expansion joint or disconnect the rail (MV 3.2).

NOTICE

Self-locking nut tightening torque 50 Nm.

WARNING

The accident prevention regulations must be complied with when cutting to size.

5.3 Module mounting

Module protection

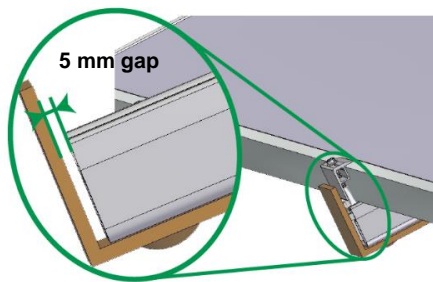

Prior to mounting the module screw the slip guard to the rail end with approx. 5 mm gap using mounting screw and self-locking nut (MV 6.1/6.2).

NOTICE

Self-locking nut tightening torque 50 Nm.

Module clamping

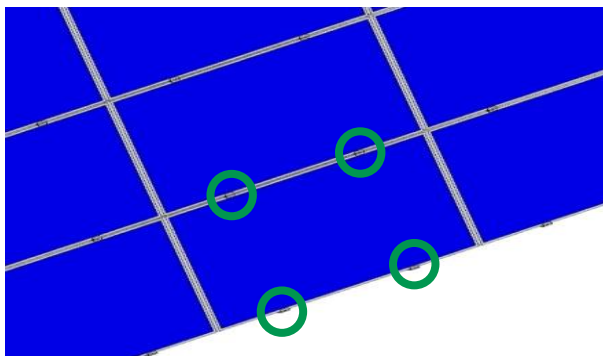

The modules must then be attached to the rails using end clamps and middle clamps.

For insertion system module mounting see MV 6

Mounting the middle and end clamps

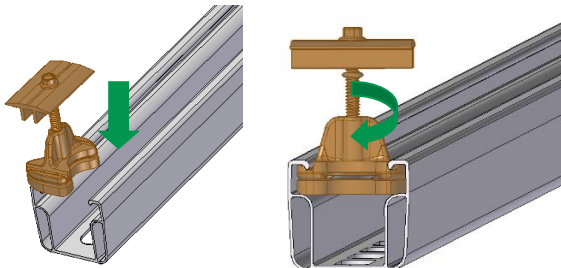

Insert the middle clamps or end clamps at the clamping position from above into the rail chamber. Then turn the rail nut in the rail and push the module clamps towards the module frame.

Space requirement for middle and end clamps

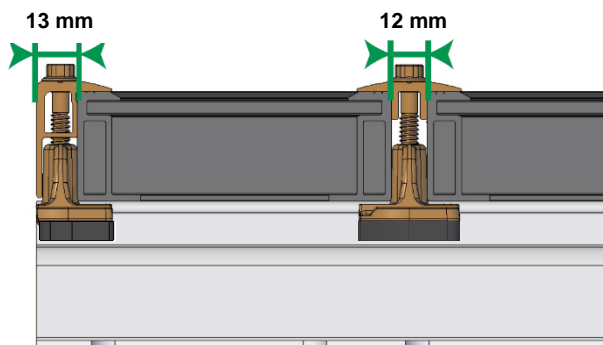

End clamp mounting flush with the rail end possible.

Push the modules all the way towards the rail nut of the middle clamps.

NOTICE

Middle clamp tightening torque 10 Nm
End clamp tightening torque 8 Nm

5.4 Mounting versions

MV 1 Stock screw – for steel purlin



Stock screw set:

Predrilling the steel

purlin

Material strength

(mm):

Predrilling the steel

purlin:

Drilling out of roof

skin:

M10

dependent on the material strength of the steel purlin

1.5<5	5<8	8<10	≥10
-------	-----	------	-----

6.8	7.0	7.2	7.4
-----	-----	-----	-----

not required

NOTICE

For steel stock screws the EPDM round seal $d = 25$ mm can additionally be used.

Height of cover H_t

up to 60 mm

61 – 105 mm

95 – 140 mm

141 – 180 mm

Stock screw length

140 mm

185 mm

220 mm

260 mm

MV 2 Shingle roof

MV 2.1 Positioning the metal shingle

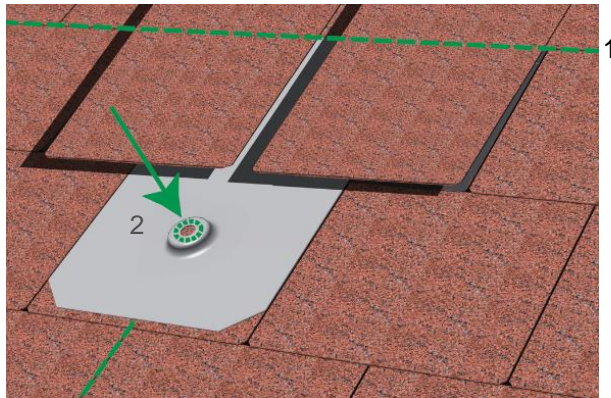

If necessary detach the shingle above, push the metal shingle flush up to the top edge of the roof shingle row below (1) and align. Then mark the position of the stock screw (2) through the hole ($d = 14$ mm) in the metal shingle and predrill the rafters through the roof cover in accordance with the stock screw size (MV 1).

MV 2.2 Attaching the stock screw and metal shingle

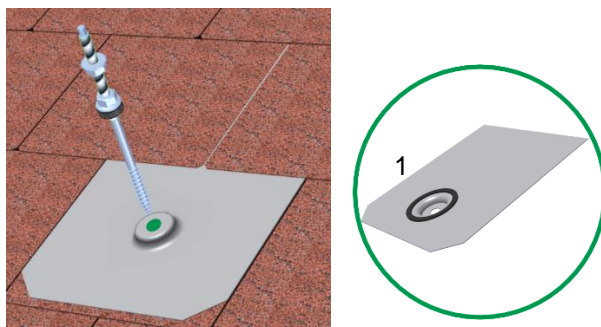

Position the projection of the metal shingle above the drill hole and screw in the stock screw.

When using the stock screw set M12 the drill hole in the metal shingle must be drilled out to 16 mm.

NOTICE

The prefitted seal at the bottom of the metal shingle (1) must adhere securely and tight.

MV 3 Rail connectors

MV 3.1 Mounting the C-rail rail connectors

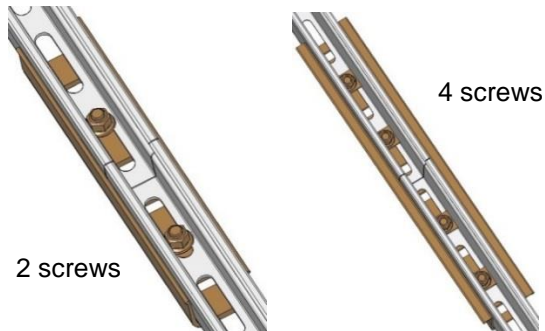

Rail connectors:

C-rail 47 (left):

Connect the adjacent rail ends with one screw and self-locking nut each.

C-rail 71 and C-rail 95 (right):

Connect the adjacent rail ends with two screws, washers and self-locking nuts each.

NOTICE

Self-locking nut tightening torque 50 Nm.

MV 3.2 Mounting expansion joints for C-rails

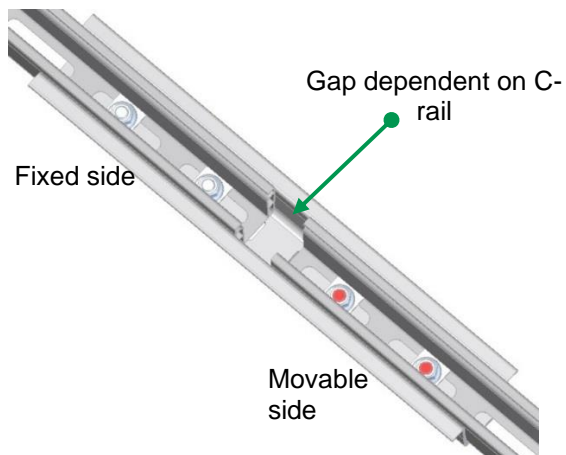

Place rail ends onto the gap, apply the rail connector and connect it to the rail at the fixed and movable sides using the mounting screws. Tighten the screws firmly on the fixed side. The screws on the movable side are coated in red and must be released again after tightening (approx. ½ turn). Maximum rail length with expansion joint 40 m, then plan proper rail disconnection.

NOTICE

Self-locking nut tightening torque fixed side 50 Nm

Distance of adjacent rail ends

C-rail 47: 20 mm

C-rail 71 and 95: 40-50 mm

WARNING

Only install expansion joints between two module fields.

MV 4 Mounting cross rail connector

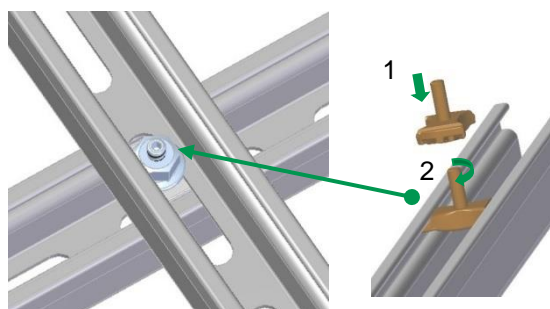

Insert the Cross rail connector sets C M14 from above into the rail groove (1) and rotate by 90° (2).

NOTICE

Cross rail connector sets C M14 tightening torque 40 Nm.

MV 5 Slip guard portrait mounting

MV 5.1 Modules with frame holes



Prior to mounting the modules the slip guards must be fitted to the frame holes above the bottom rail position.

MV 5.2 Modules with box frame

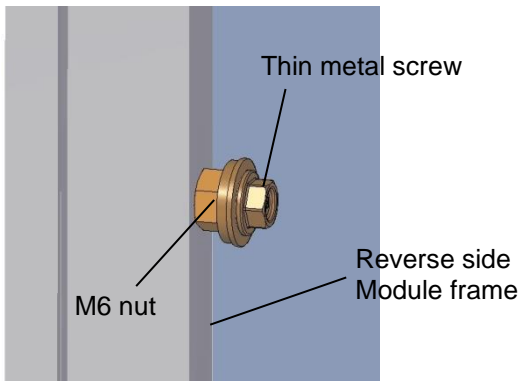

Push the nut over the screw and screw the thin metal screw into the module frame without predrilling.

NOTICE

The thin metal screw must not be overtightened.

MV 6 Insertion system

MV 6.1 Cross rail connector IR

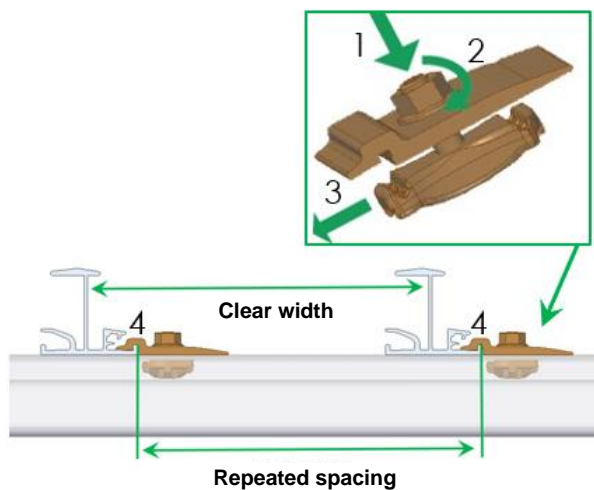

Insert the Cross rail connector set C IR M8 into the rail groove (1) from above. Rotate the nut by 90° (2) and push the component against the insertion rail (3) until the Cross rail connector set C IR M8 engages with the mounting flange (4).

NOTICE

Mounting set insertion rail M8 tightening torque 25 Nm.

Repeated spacing = module length L + 12 mm

Clear rail width = module length L + 10 mm

For mounting modules in landscape the module width instead of the module length must be used.

MV 6.2 Position of the cross rail connector IR

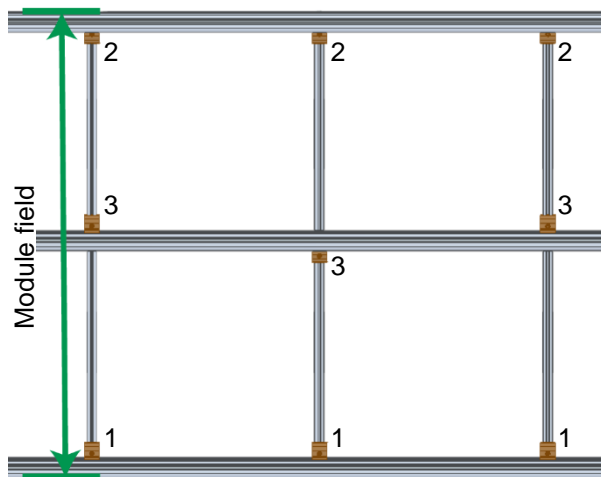

For the top and bottom insertion rail of the module field the mounting set insertion rail M8 is fitted on the inside in each case (1, 2). At the centre insertion rails the mounting set insertion rail M8 must be fitted alternating at the top and bottom at the mounting flange (3).

NOTICE

Module field length =
Repeated spacing x number of module fields
+ width of insertion rail

MV 6.3 Mounting the insertion rail connectors

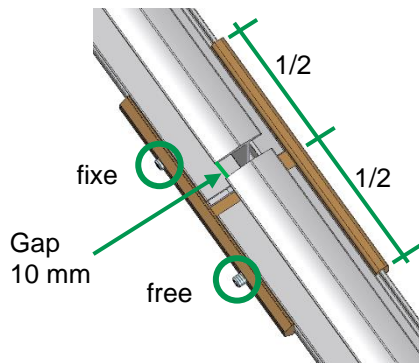

Centre the rail connector over the fitted rail and tighten the first threaded pin. Push the rail to be connected into the connector. Gap between rails 10 mm, tighten the second threaded pin without play. MV 7 must be complied with for the mounting of the Insertion Rail Plus rails.

NOTICE

Do not fit connectors at the cantilever and above the drop rail.
Threaded pin without play for longitudinal expansion.

MV 6.4 Module mounting: insertion system

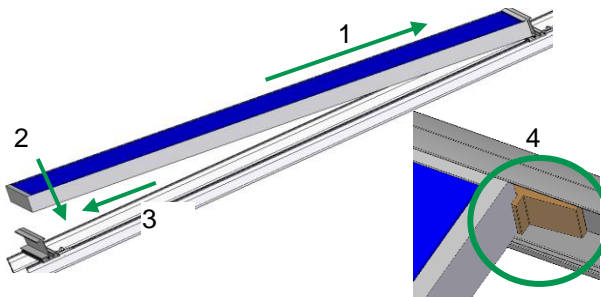

Place the module onto the top insertion rail and push it up (1). Then lower the module onto the bottom insertion rail (2) and push it down against the insertion rail (3). Mount the next modules following the same principle, the gap between the modules must be min. 3 mm.

NOTICE

Install the EPDM-T protection IR between the modules (4) with a module inclination <math>< 10^\circ</math> or as theft protection.

MV 6.5 Edge stop mounting

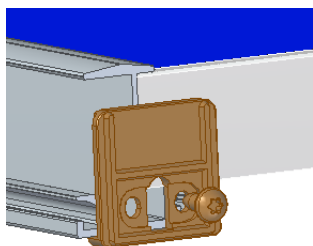

Fit an edge stop at the end of a module row at each insertion rail with a metal screw in the screw channel.
For the Insertion Rail Plus use the matching end cap (MV 7.4).

NOTICE

The opening of the edge stop must expose the drainage channel of the insertion rail.

MV 7 Heavy snow loads

MV 7.1 Insertion Rail Plus mounting

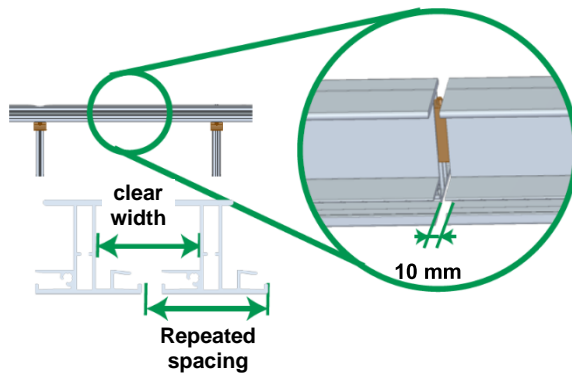

Attach the Insertion Rail Plus to the C-rails with mounting set insertion rail M8 as the insertion rail. Insert the connector for Insertion rail Plus up to the stop and push the second rail with a distance of 10 mm over the rail connector.

NOTICE

Repeated spacing = module length L + 22 mm
Clear rail width = module length L + 10 mm

MV 7.2 Mounting the support rail IR

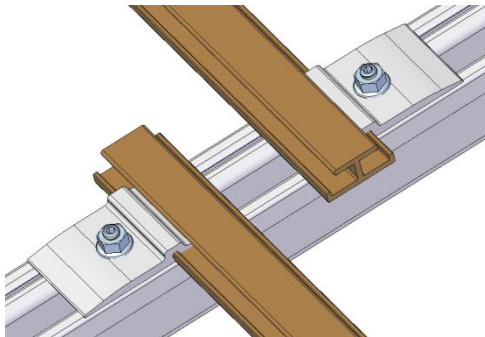

Attach the support rail IR with the Cross rail connector set C IR M8 - the support rails must be fitted parallel to the insertion rails and must be offset on the C-rail in the overlap area.

NOTICE

A 6.0 m long support rail must be attached with min. 3 cross rail connector set C IR M8.

MV 7.3 Distributing the round snow guard pipes

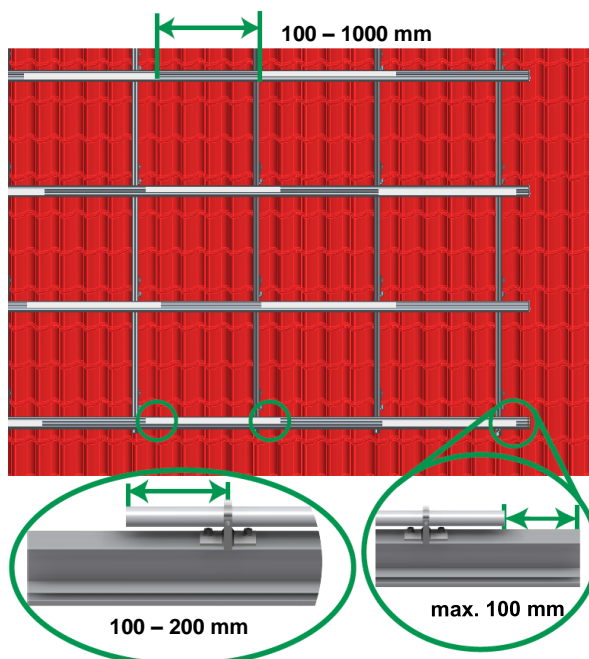

Distance between Aluminium round pipes at the end of the insertion rail in the corner area of the system max. 100 mm.
Distance between round pipes min. 100 mm and max. 1000 mm.
For each 800 mm round pipe at least two brackets must be mounted at a distance of 100 – 200 mm from the end of the pipe.

The same mounting instructions apply to 6.0 m round pipes. Mounting distance of the brackets here is 500 – 600 mm each.

NOTICE

Arrange stop ES 20 x 5 aluminium round pipes per row of rails in a staggered arrangement, observing the minimum and maximum distances.

MV 7.4 Attaching the bracket and mounting the edge stop

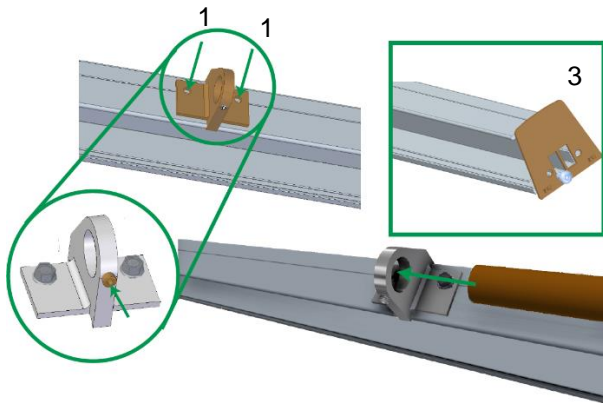

The brackets must be fitted with two drilling screws (1) to the Insertion rail Plus. Position the rounded pipes centred and secure them with the grub screw (2).

Fit an end cap on the screw channel as edge stop at the end of a module row at each insertion rail with a metal screw (3).

NOTICE

If rounded pipes pass over a rail joint, only tighten one grub screw.

The openings of the end cap must expose the drainage channels of the insertion rail.

MV 8 Grounding

MV 8.1 Assembly of grounding connectors

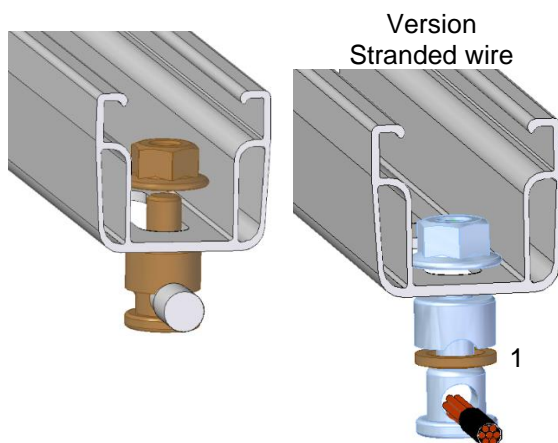

Earthing wire (\varnothing according to national specifications):

Remove grounding connector, remove clamping disk (1). Push component through C-rail slot from below. Push earthing wire through the opening (suitable for \varnothing 6-10 mm) and attach the component to the rail floor with the self-locking nut.

Earthing cable (\varnothing according to national specifications):

Strip earthing cable (e.g. stranded wire) and push it through the opening. Leave the clamping disk in place (1). Clamp to the rail floor with the self-locking nut.

NOTICE

Earthing wire tightening torque 20 Nm or earthing cable 10 Nm.

⚠ WARNING

The applicable standards and guidelines, e.g. lightning protection standard, must be observed.

MV 8.2 Assembly of contact latch

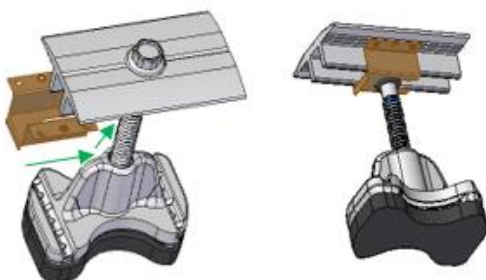

Push the contact latch on the sliding plate over the vertical webs of the middle clamp up to the screw.

NOTICE

Mounting of the middle clamp with the contact latch attached is carried out as described previously in chapter 5.3.

6 Warranty / product liability (exclusion)

In addition to the above-mentioned regulations and safety notices the applicable regulations and rules of technology must be observed by the installing specialist company.

The installer is responsible for the dimensioning of the mounting system.

The installer is responsible for the connection of the interfaces between the mounting system and the building. This also includes the tightness of the building envelope.

For flat roofs the roof insulation must be evaluated by the installer on site within his own responsibility regarding the material of the sealing layer, resistance, ageing, compatibility with other materials, overall condition of the roof insulation, need for a separating layer between the roof insulation and the mounting system. The required and necessary measures or precautions for the protection of the roof insulation for the mounting of the substructure of a PV system must be initiated by the installer with the aid of a specialist tradesman where necessary. novotegra GmbH does not accept liability for faulty or inadequate measures and precautions for the protection of the roof insulation!

The installer must review the friction coefficient used in the calculation for the verification of the slip safety of PV systems on flat roofs on site. Friction coefficients determined on site can be taken into account by entering them in the Solar-Planit planning tool. novotegra GmbH does not guarantee the correctness of the assumed values and is not liable for damage due to the use of incorrect values.

The specifications of the module, cable and inverter manufacturers must be observed. If these contradict the mounting instructions, always consult the novotegra GmbH sales team before mounting the novotegra mounting system or – in the case of components not supplied by novotegra GmbH – the manufacturer concerned.

During the preparation of the offers for novotegra by our sales staff the local conditions are not always sufficiently known, which is why changes to the offered quantities may result during installation. These changes relate mainly to the number of fasteners for the building envelope (for example roof hooks). In this case the additionally required components must always be installed in accordance with the dimensioning.

novotegra GmbH is not liable for incorrect or incomplete data collection sheets. Error-free and fully completed data collection sheets are essential for correct dimensioning.

The information in the mounting instructions, the warranty terms and the information about the liability exclusion must be noted.



novotegra

novotegra GmbH

Eisenbahnstraße 150
72072 Tübingen | Deutschland

Tel. +49 7071 98987-0
Fax +49 7071 98987-10

info@novotegra.com
www.novotegra.com

